

Chapter 2: Pressure and Fluid Statics

Pressure

For a static fluid, the only stress is the normal stress since by definition a fluid subjected to a shear stress must deform and undergo motion. Normal stresses are referred to as pressure p .

For the general case, the stress on a fluid element or at a point is a tensor

$\tau_{ij} = \text{stress tensor}^*$

$$= \begin{bmatrix} \tau_{xx} & \tau_{xy} & \tau_{xz} \\ \tau_{yx} & \tau_{yy} & \tau_{yz} \\ \tau_{zx} & \tau_{zy} & \tau_{zz} \end{bmatrix}$$

$i = \text{face}$
 $j = \text{direction}$

*Tensor: A mathematical object analogous to but more general than a vector, represented by an array of components that are functions of the coordinates of a space (Oxford)

For a static fluid,

$$\tau_{ij} = 0 \quad i \neq j \quad \text{shear stresses} = 0$$

$$\tau_{ii} = -p = \tau_{xx} = \tau_{yy} = \tau_{zz} \quad i = j \quad \text{normal stresses} = -p$$

Also shows that p is isotropic, one value at a point which is independent of direction, a scalar.

Definition of Pressure:

$$p = \lim_{\delta A \rightarrow 0} \frac{\delta F}{\delta A} = \frac{dF}{dA} \quad \text{N/m}^2 = \text{Pa (Pascal)}$$

F = normal force acting over A

As already noted, p is a scalar, which can be easily demonstrated by considering the equilibrium of forces on a wedge-shaped fluid element

Geometry

$$\Delta A = \Delta l \Delta y$$

$$\Delta x = \Delta l \cos \alpha$$

$$\Delta z = \Delta l \sin \alpha$$

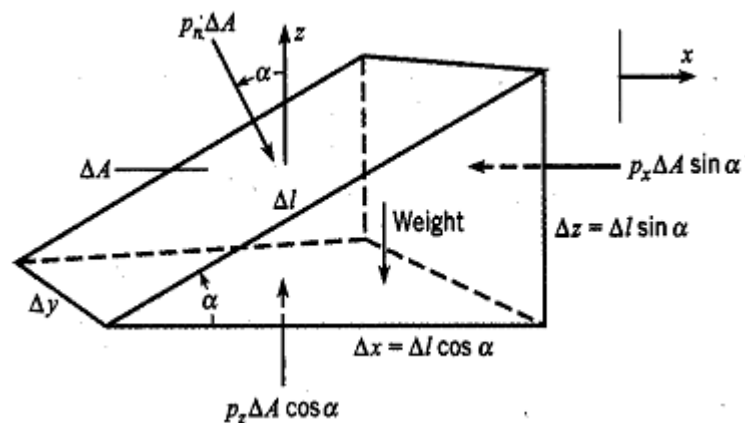

$$\Sigma F_x = 0$$

$$p_n \Delta A \sin \alpha - p_x \Delta A \sin \alpha = 0$$

$$p_n = p_x$$

$$W = mg$$

$$= \rho V g$$

$$= \gamma V$$

$$\Sigma F_z = 0$$

$$V = \frac{1}{2} \Delta x \Delta z \Delta y$$

$$-p_n \Delta A \cos \alpha + p_z \Delta A \cos \alpha - W = 0$$

$$W = \frac{\gamma}{2} \underbrace{(\Delta l \cos \alpha)}_{\Delta x} \underbrace{(\Delta l \sin \alpha)}_{\Delta z} \Delta y$$

$$-p_n \Delta l \Delta y \cos \alpha + p_z \Delta l \Delta y \cos \alpha - \frac{\gamma}{2} \Delta l^2 \cos \alpha \sin \alpha \Delta y = 0$$

$$-p_n + p_z - \frac{\gamma}{2} \Delta \ell \sin \alpha = 0$$

$$p_n = p_z \quad \text{for } \Delta \ell \rightarrow 0$$

i.e., $p_n = p_x = p_y = p_z$

p is single valued at a point and independent of direction.

A body/surface in contact with a static fluid experiences a force due to p

$$\underline{F}_p = - \int_{S_B} p \underline{n} dA$$

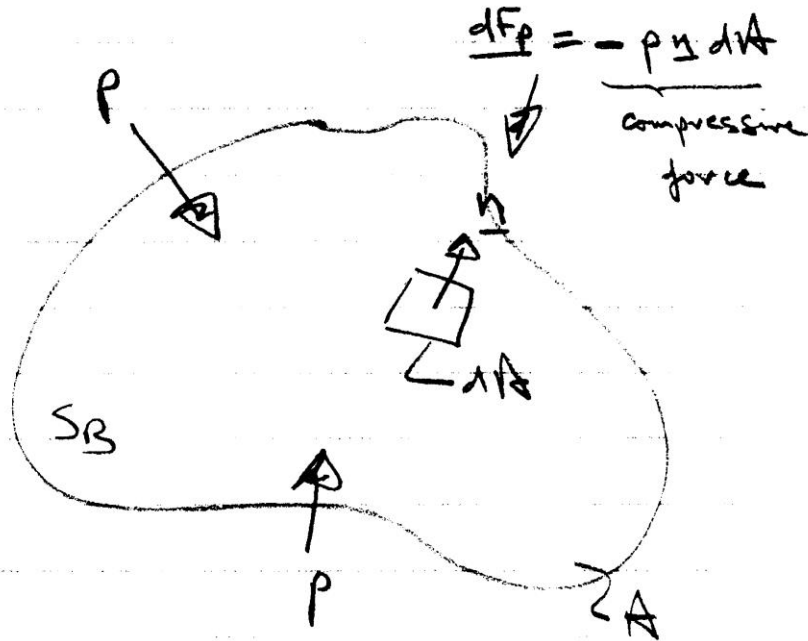

Note: if $p = \text{constant}$, $\underline{F}_p = 0$ for a closed body.

Scalar form of Green's Theorem:

$$\int_s f \underline{n} ds = \int_v \nabla f dV \quad f = \text{constant} \Rightarrow \nabla f = 0$$

Pressure Transmission

Pascal's law: in a closed system, a pressure change produced at one point in the system is transmitted throughout the entire system.

Absolute Pressure, Gage Pressure, and Vacuum

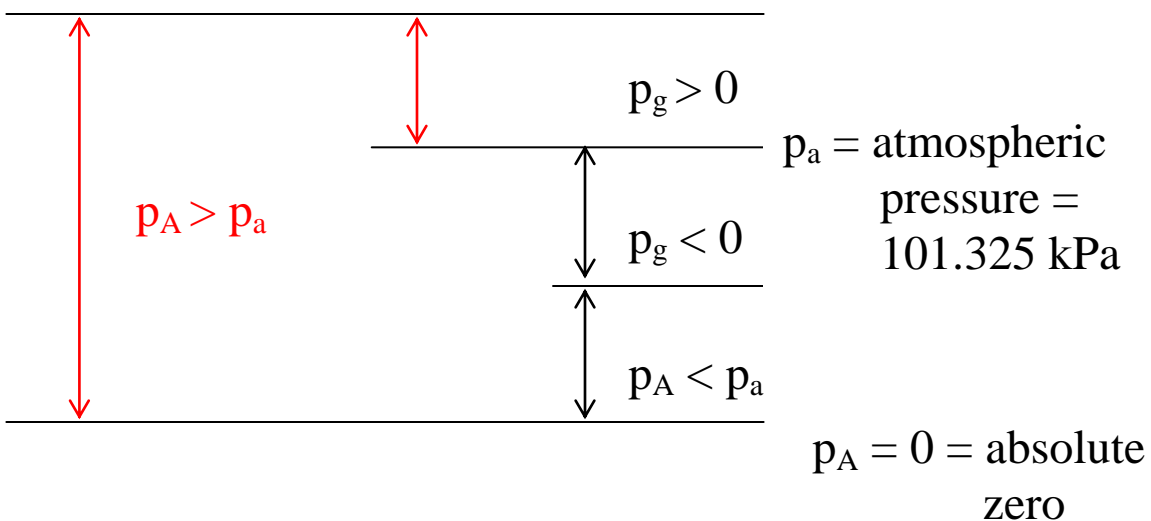

For $p_A > p_a$, $p_g = p_A - p_a = \text{gage pressure}$

For $p_A < p_a$, $p_{\text{vac}} = -p_g = p_a - p_A = \text{vacuum pressure}$

Pressure Variation with Elevation

Basic Differential Equation

For a static fluid, pressure varies only with elevation within the fluid. This can be shown by consideration of equilibrium of forces on a fluid element

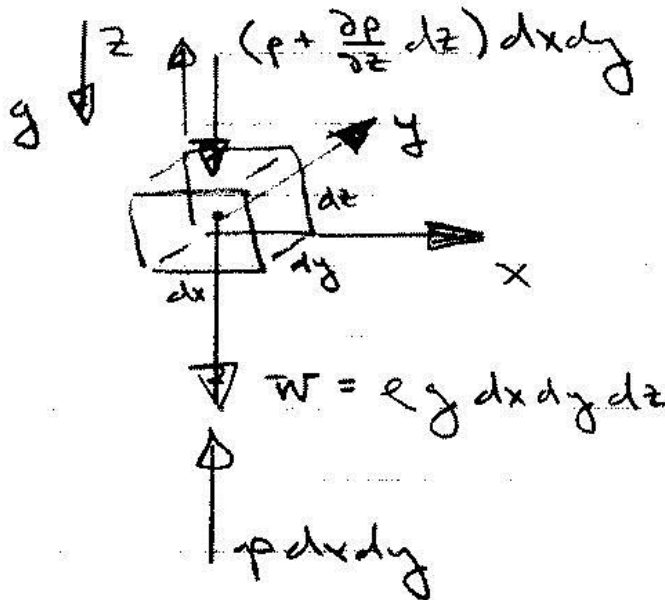

1st order Taylor series estimate for pressure variation over dz

Newton's law (momentum principle) applied to a static fluid

$$\Sigma \underline{F} = m \underline{a} = 0 \text{ for a static fluid}$$

$$\text{i.e., } \Sigma F_x = \Sigma F_y = \Sigma F_z = 0$$

$$\Sigma F_z = 0$$

$$p dx dy - \left(p + \frac{\partial p}{\partial z} dz \right) dx dy - \rho g dx dy dz = 0$$

$$\frac{\partial p}{\partial z} = -\rho g = -\gamma$$

Basic equation for pressure variation with elevation

$$\Sigma F_y = 0$$

$$\Sigma F_x = 0$$

$$p dx dz - (p + \frac{\partial p}{\partial y} dy) dx dz = 0 \quad p dy dz - (p + \frac{\partial p}{\partial x} dx) dy dz = 0$$

$$\frac{\partial p}{\partial y} = 0$$

$$\frac{\partial p}{\partial x} = 0$$

For a static fluid, the pressure only varies with elevation z and is constant in horizontal xy planes.

The basic equation for pressure variation with elevation can be integrated depending on whether $\rho = \text{constant}$ or $\rho = \rho(z)$, i.e., whether the fluid is incompressible (liquid or low-speed gas) or compressible (high-speed gas) since $g \sim \text{constant}$

Pressure Variation for a Uniform-Density Fluid

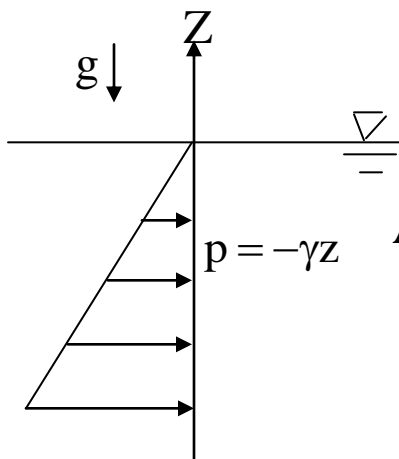

$$\frac{\partial p}{\partial z} = -\rho g = -\gamma \quad \rho = \text{constant for liquid}$$

$$\Delta p = -\gamma \Delta z$$

$$p_2 - p_1 = -\gamma (z_2 - z_1)$$

Alternate forms:

$$p_1 + \gamma z_1 = p_2 + \gamma z_2 = \text{constant}$$

$$p + \gamma z = \text{constant} \quad \text{piezometric pressure}$$

$$p(z = 0) = 0 \quad \text{gage}$$

i.e., $p = -\gamma z$ increase linearly with depth
 decrease linearly with height

$$\frac{p}{\gamma} + z = \text{constant} \quad \text{piezometric head}$$

EXAMPLE 3.4

Oil with a specific gravity of 0.80 forms a layer 0.90 m deep in an open tank that is otherwise filled with water. The total depth of water and oil is 3 m. What is the gage pressure at the bottom of the tank?

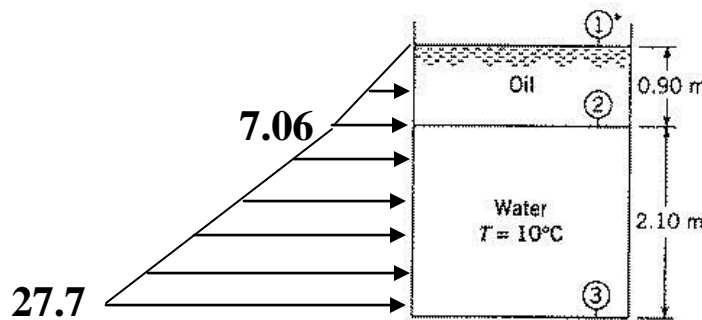

$$p + \gamma z = \text{constant}$$

$$p_1 + \gamma z_1 = p_2 + \gamma z_2$$

$$p_2 = p_1 + \gamma(z_1 - z_2)$$

$$p_1 = p_{\text{atm}} = 0$$

$$p_2 = \gamma_{\text{oil}} \Delta z = 0.8 \times 9810 \times 0.9 = 7.06 \text{ kPa}$$

$$p_3 = p_2 + \gamma_{\text{water}}(z_2 - z_3)$$

$$= 7060 + 9810 \times 2.1$$

$$= 27.7 \text{ kPa}$$

Solution First determine the pressure at the oil–water interface, staying within the oil, and then calculate the pressure at the bottom.

$$\frac{p_1}{\gamma} + z_1 = \frac{p_2}{\gamma} + z_2$$

where p_1 is the pressure at free surface of oil, z_1 is the elevation of free surface of oil, p_2 is the pressure at interface between oil and water, and z_2 is the elevation at interface between oil and water. For this example, $p_1 = 0$, $\gamma = 0.80 \times 9810 \text{ N/m}^3$, $z_1 = 3 \text{ m}$, and $z_2 = 2.10 \text{ m}$. Therefore,

$$p_2 = 0.90 \text{ m} \times 0.80 \times 9810 \text{ N/m}^3 = 7.06 \text{ kPa gage}$$

Now obtain p_3 from

$$\frac{p_2}{\gamma} + z_2 = \frac{p_3}{\gamma} + z_3$$

where p_2 has already been calculated and $\gamma = 9810 \text{ N/m}^3$.

$$p_3 = 9810 \left(\frac{7060}{9810} + 2.10 \right) = 27.7 \text{ kPa gage}$$

Pressure Variation for Compressible Fluids:

Basic equation for pressure variation with elevation

$$\frac{dp}{dz} = -\gamma = -\gamma(p, z) = -\rho g$$

Pressure variation equation can be integrated for $\gamma(p, z)$ known. For example, here we solve for the pressure in the atmosphere assuming $\rho(p, T)$ given from ideal gas law, $T(z)$ known, and $g \neq g(z)$.

$$p = \rho RT$$

$R =$ gas constant $= 287 \text{ J/kg} \cdot ^\circ\text{K}$ dry air
 p, T in absolute scale

$$\frac{dp}{dz} = -\frac{pg}{RT}$$

$$\frac{dp}{p} = \frac{-g}{R} \frac{dz}{T(z)}$$

which can be integrated for $T(z)$ known

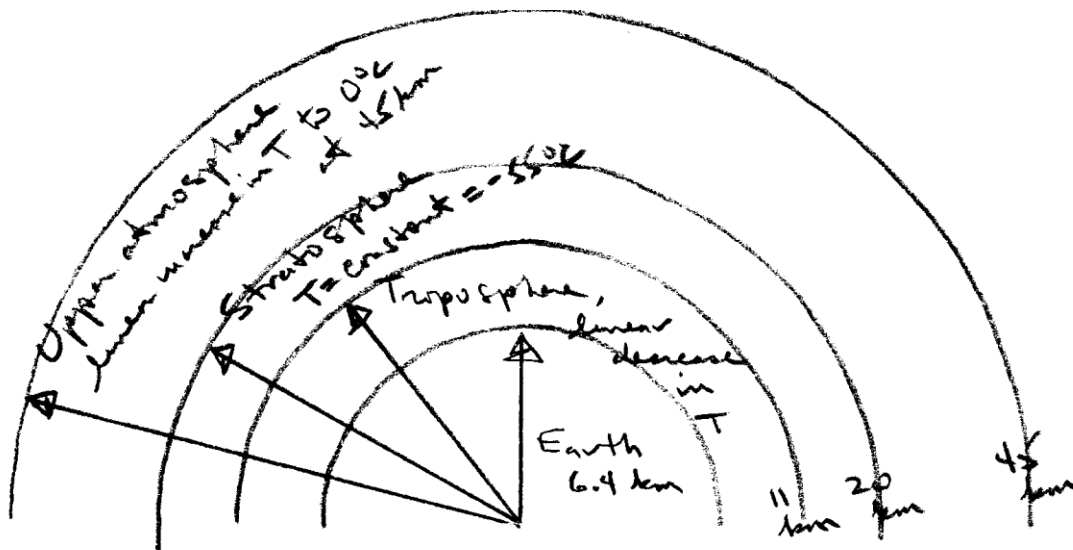

Pressure Variation in the Troposphere

$$T = T_o - \alpha(z - z_o) \quad \text{linear decrease}$$

$$T_o = T(z_o) \quad \text{where } p = p_o(z_o) \text{ known}$$
$$\alpha = \text{lapse rate} = 6.5 \text{ }^\circ\text{K/km}$$

$$\frac{dp}{p} = -\frac{g}{R [T_o - \alpha(z - z_o)]} dz \quad \begin{array}{l} z' = T_o - \alpha(z - z_o) \\ dz' = \alpha dz \end{array}$$

$$\ln p = \frac{g}{\alpha R} \ln [T_o - \alpha(z - z_o)] + \text{constant}$$

use reference condition

$$\ln p_o = \frac{g}{\alpha R} \ln T_o + \text{constant}$$

solve for constant

$$\ln \frac{p}{p_o} = \frac{g}{\alpha R} \ln \frac{T_o - \alpha(z - z_o)}{T_o}$$

$$\frac{p}{p_o} = \left[\frac{T_o - \alpha(z - z_o)}{T_o} \right]^{g/\alpha R}$$

i.e., p decreases for increasing z

$z_o = \text{earth surface}$ $= 0$

$p_o = 101.3 \text{ kPa}$

$T = 15^\circ\text{C}$

$\alpha = 6.5 \text{ }^\circ\text{K/km}$
--

Pressure Variation in the Stratosphere

$$T = T_s = -55^\circ\text{C}$$

$$\frac{dp}{p} = -\frac{g}{R T_s} dz$$

$$\ln p = -\frac{g}{R T_s} z + \text{constant}$$

use reference condition to find constant

$$\frac{p}{p_o} = e^{-(z-z_o)g/RT_s}$$

$$p = p_o \exp[-(z - z_o)g/RT_s]$$

i.e., p decreases exponentially for increasing z .

Pressure Measurements

Pressure is an important variable in fluid mechanics and many instruments have been devised for its measurement. Many devices are based on hydrostatics such as barometers and manometers, i.e., determine pressure through measurement of a column (or columns) of a liquid using the pressure variation with elevation equation for an incompressible fluid.

Differential manometer

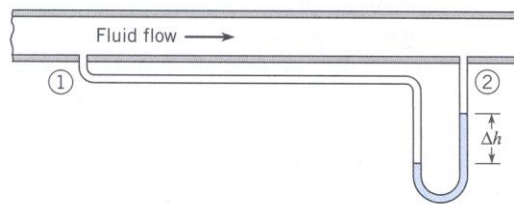

More modern devices include Bourdon-Tube Gage (mechanical device based on deflection of a spring) and pressure transducers (based on deflection of a flexible diaphragm/membrane). The deflection can be monitored by a strain gage such that voltage output is $\propto \Delta p$ across diaphragm, which enables electronic data acquisition with computers.

Bourdon-Tube Gage

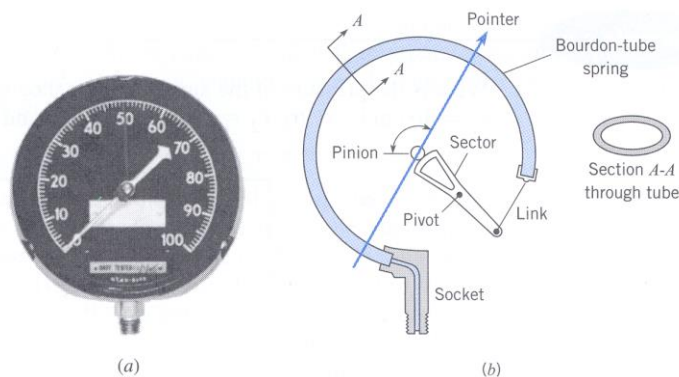

In this course we will use both manometers and pressure transducers in EFD labs 2 and 3.

Manometry

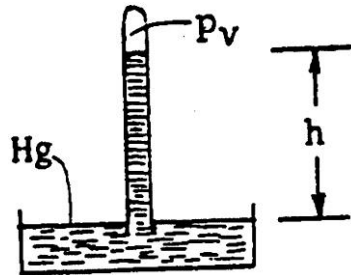

1. Barometer

$$p_v + \gamma_{\text{Hg}}h = p_{\text{atm}} \quad \gamma_{\text{Hg}} = 13.6 \text{ kN/m}^3$$

$$p_{\text{atm}} = \gamma_{\text{Hg}}h \quad p_v \sim 0 \text{ i.e., vapor pressure Hg}$$

nearly zero at normal T

$$h \sim 76 \text{ cm}$$

$$\therefore p_{\text{atm}} \sim 101 \text{ kPa (or 14.6 psia)}$$

Note: p_{atm} is relative to absolute zero, i.e., absolute pressure. $p_{\text{atm}} = p_{\text{atm}}(\text{location, weather})$

Consider why water barometer is impractical

$$\gamma_{\text{Hg}}h_{\text{Hg}} = \gamma_{\text{H}_2\text{O}}h_{\text{H}_2\text{O}} \quad \gamma_{\text{H}_2\text{O}} = 9.80 \text{ kN/m}^3$$

$$h_{\text{H}_2\text{O}} = \frac{\gamma_{\text{Hg}}}{\gamma_{\text{H}_2\text{O}}} h_{\text{Hg}} = S_{\text{Hg}} h_{\text{Hg}} = 13.6 \times 77 = 1047.2 \text{ cm} = 34 \text{ ft.}$$

2. Piezometer

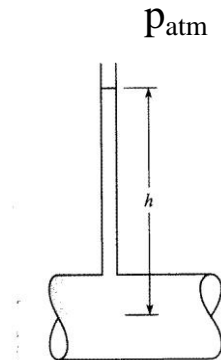

$$p_{\text{atm}} + \gamma h = p_{\text{pipe}} = p \quad \text{absolute}$$

$$p = \gamma h \quad \text{gage}$$

Simple but impractical for large p and vacuum pressures (i.e., $p_{\text{abs}} < p_{\text{atm}}$). Also for small p and small d , due to large surface tension effects, which could be corrected using $\Delta h = 4\sigma/\gamma d$, but accuracy may be problem if $p/\gamma \approx \Delta h$.

3. U-tube or differential manometer

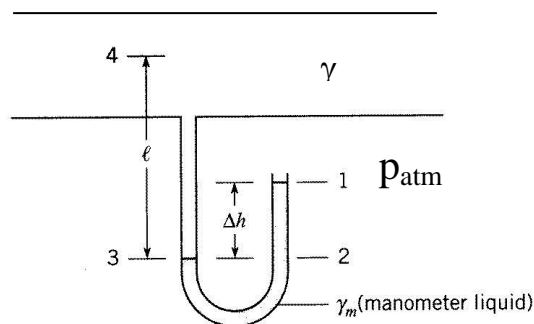

$$\begin{aligned}
 p_1 + \gamma_m \Delta h - \gamma l &= p_4 & p_1 &= p_{\text{atm}} \\
 p_4 &= \gamma_m \Delta h - \gamma l & & \text{gage} \\
 &= \gamma_w [S_m \Delta h - S l] & &
 \end{aligned}$$

for gases $S \ll S_m$ and can be neglected, i.e., can neglect Δp in gas compared to Δp in liquid in determining $p_4 = p_{\text{pipe}}$.

Example:

Air at 20 °C is in pipe with a water manometer. For given conditions compute gage pressure in pipe.

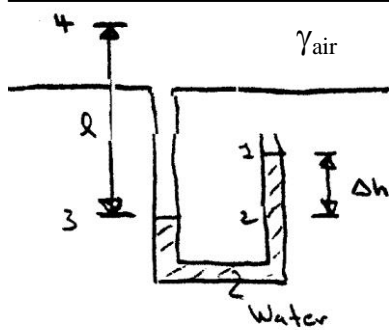

$$l = 140 \text{ cm}$$

$$\Delta h = 70 \text{ cm}$$

$$p_4 = ? \text{ gage (i.e., } p_1 = 0)$$

Pressure same at 2&3 since same elevation & Pascal's law: in closed system pressure change produce at one part transmitted throughout entire system

~~$p_1 + \gamma \Delta h = p_3$~~ step-by-step method

$\gamma \Delta h \rightarrow p_3 - \gamma_{\text{air}} l = p_4$

$$p_1 + \gamma \Delta h - \gamma_{\text{air}} l = p_4 \quad \text{complete circuit method}$$

$$\gamma \Delta h - \gamma_{\text{air}} l = p_4 \quad \text{gage}$$

$$\gamma_{\text{water}}(20^\circ\text{C}) = 9790 \text{ N/m}^3 \Rightarrow p_3 = \gamma \Delta h = 6853 \text{ Pa [N/m}^2]$$

$$\gamma_{\text{air}} = \rho g$$

$$\rho = \frac{p}{RT} = \frac{(p_3 + p_{\text{atm}})}{R(\text{°C} + 273)} = \frac{6853 + 101300}{287(20 + 273)} = 1.286 \text{ kg/m}^3$$

\swarrow p_{abs}
 \swarrow °K

$$\gamma_{\text{air}} = 1.286 \times 9.81 \text{ m/s}^2 = 12.62 \text{ N/m}^3$$

note $\gamma_{\text{air}} \ll \gamma_{\text{water}}$

$$p_4 = p_3 - \gamma_{\text{air}} l = 6853 - \underbrace{12.62 \times 1.4}_{17.668} = 6835 \text{ Pa}$$

if neglect effect of air column

$$p_4 = 6853 \text{ Pa}$$

A differential manometer determines the difference in pressures at two points ① and ② when the actual pressure at any point in the system cannot be determined.

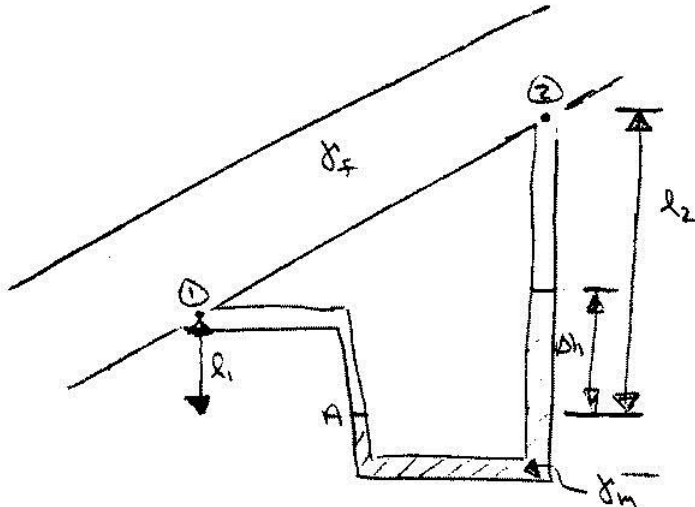

$$p_1 + \gamma_f l_1 - \gamma_m \Delta h - \gamma_f (l_2 - \Delta h) = p_2$$

$$p_1 - p_2 = \gamma_f (l_2 - l_1) + (\gamma_m - \gamma_f) \Delta h$$

$$\left(\frac{p_1}{\gamma_f} + l_1 \right) - \left(\frac{p_2}{\gamma_f} + l_2 \right) = \left(\frac{\gamma_m}{\gamma_f} - 1 \right) \Delta h$$

⏟
 difference in piezometric head

★ if fluid is a gas $\gamma_f \ll \gamma_m$: $p_1 - p_2 = \gamma_m \Delta h$

★ if fluid is liquid & pipe horizontal $l_1 = l_2$:

$$p_1 - p_2 = (\gamma_m - \gamma_f) \Delta h$$

Hydrostatic Forces on Plane Surfaces

For a static fluid, the shear stress is zero and the only stress is the normal stress, i.e., pressure p . Recall that p is a scalar, which when in contact with a solid surface exerts a normal force towards the surface.

$$\underline{F}_p = - \int_A p \underline{n} dA$$

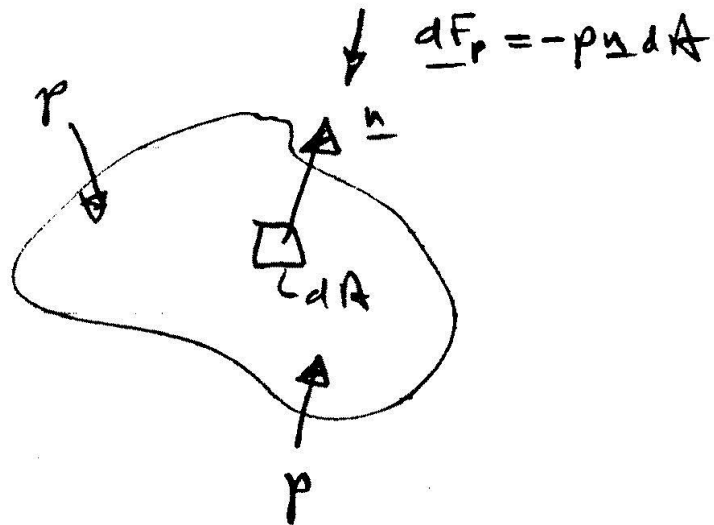

For a plane surface $\underline{n} = \text{constant}$ such that we can separately consider the magnitude and line of action of \underline{F}_p .

$$|\underline{F}_p| = F = \int_A p dA$$

Line of action is towards and normal to A through the center of pressure (x_{cp}, y_{cp}) .

Unless otherwise stated, throughout the chapter assume p_{atm} acts at liquid surface. Also, we will use gage pressure so that $p = 0$ at the liquid surface.

Horizontal Surfaces

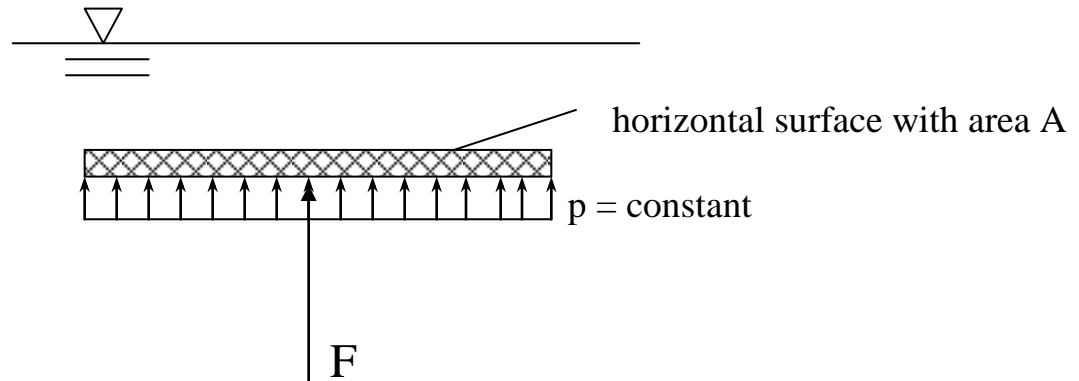

$$F = \int p dA = pA$$

Line of action is through centroid of A,
i.e., $(x_{cp}, y_{cp}) = (\bar{x}, \bar{y})$

Inclined Surfaces

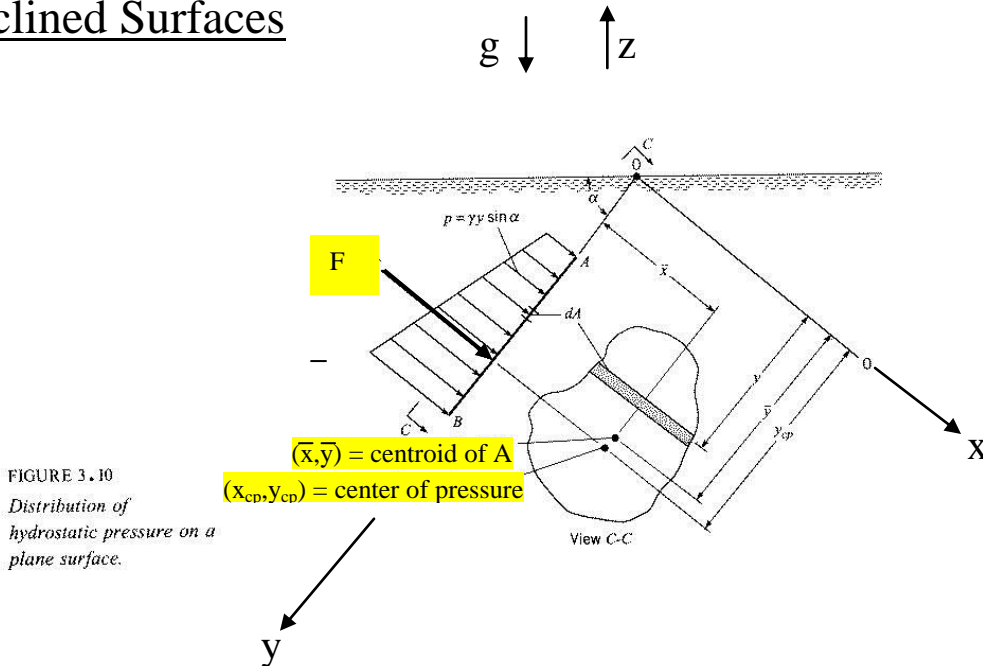

$$\frac{dp}{dz} = -\gamma$$

$$\Delta p = -\gamma \Delta z$$

$$p - p_0 = -\gamma(z - z_0) \text{ where } p_0 = 0 \text{ \& } z_0 = 0$$

$$p = -\gamma z \text{ and } y \cdot \sin \alpha = -z$$

$$p = \gamma y \cdot \sin \alpha$$

$$dF = p dA = \underbrace{\gamma y \sin \alpha}_p dA$$

γ and $\sin \alpha$ are constants

$$F = \int_A p dA = \gamma \sin \alpha \int_A y dA = \gamma \sin \alpha \underbrace{\int_A y dA}_{\bar{y}A}$$

$$\bar{y} = \frac{1}{A} \int y dA$$

1st moment of area

$$F = \underbrace{\gamma \sin \alpha}_{\bar{p}} \bar{y} A$$

$\bar{p} = \text{pressure at centroid of } A$

$$F = \bar{p}A$$

Magnitude of resultant hydrostatic force on plane surface is product of pressure at centroid of area and area of surface.

Center of Pressure

Center of pressure is in general below centroid since pressure increases with depth. Center of pressure is determined by equating the moments of the resultant and distributed forces about any arbitrary axis.

Determine y_{cp} by taking moments about horizontal axis 0-0

$$\begin{aligned} y_{cp}F &= \int_A y dF \\ &= \int_A y p dA \\ &= \int_A y (\gamma y \sin \alpha) dA \\ &= \gamma \sin \alpha \underbrace{\int_A y^2 dA} \end{aligned}$$

$I_o = 2^{nd}$ moment of area about 0-0
= moment of inertia

transfer equation: $I_o = \bar{y}^2 A + \bar{I}$

\bar{I} = moment of inertia with respect to horizontal centroidal axis

$$y_{cp} F = \gamma \sin \alpha (\bar{y}^2 A + \bar{I})$$

$$y_{cp} (\bar{p}A) = \gamma \sin \alpha (\bar{y}^2 A + \bar{I})$$

$$y_{cp} \gamma \sin \alpha \bar{y}A = \gamma \sin \alpha (\bar{y}^2 A + \bar{I})$$

$$y_{cp} \bar{y}A = \bar{y}^2 A + \bar{I}$$

$$y_{cp} = \bar{y} + \frac{\bar{I}}{\bar{y}A}$$

y_{cp} is below centroid by $\bar{I}/\bar{y}A$

$y_{cp} \rightarrow \bar{y}$ for large \bar{y}

For $p_o \neq 0$, y must be measured from an equivalent free surface located p_o/γ above \bar{y} .

Determine x_{cp} by taking moment about y axis

$$x_{cp}F = \int_A x dF$$
$$\int_A x p dA$$

$$x_{cp}(\bar{\gamma} \bar{y} \sin \alpha A) = \int_A x(\gamma y \sin \alpha) dA$$

$$x_{cp} \bar{y} A = \underbrace{\int_A xy dA}$$

I_{xy} = product of inertia

$$= \bar{I}_{xy} + \bar{x} \bar{y} A \quad \text{transfer equation}$$

$$x_{cp} \bar{y} A = \bar{I}_{xy} + \bar{x} \bar{y} A$$

$$x_{cp} = \frac{\bar{I}_{xy}}{\bar{y} A} + \bar{x}$$

For plane surfaces with symmetry about an axis normal to 0-0, $\bar{I}_{xy} = 0$ and $x_{cp} = \bar{x}$.

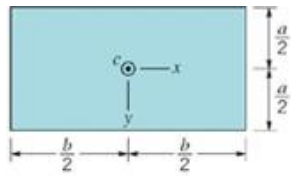

$$A = ba$$

$$I_{xx} = \frac{1}{12} ba^3$$

$$I_{yy} = \frac{1}{12} ab^3$$

$$I_{xy} = 0$$

(a) Rectangle

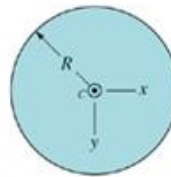

$$A = \pi R^2$$

$$I_{xx} = I_{yy} = \frac{\pi R^4}{4}$$

$$I_{xy} = 0$$

(b) Circle

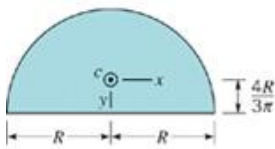

$$A = \frac{\pi R^2}{2}$$

$$I_{xx} = 0.1098R^4$$

$$I_{yy} = 0.3927R^4$$

$$I_{xy} = 0$$

(c) Semicircle

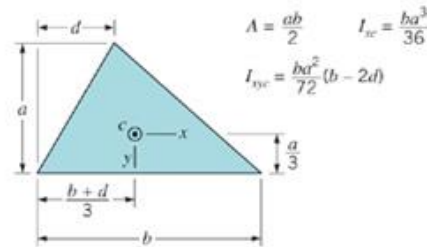

$$A = \frac{ab}{2}$$

$$I_{xx} = \frac{ba^3}{36}$$

$$I_{yy} = \frac{ba^2}{72}(b-2d)$$

(d) Triangle

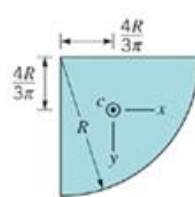

$$A = \frac{\pi R^2}{4}$$

$$I_{xx} = I_{yy} = 0.05488R^4$$

$$I_{xy} = -0.01647R^4$$

(e) Quarter circle

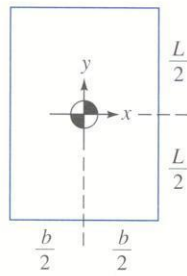

$$A = bL$$

$$I_{xx} = \frac{bL^3}{12}$$

$$I_{xy} = 0$$

(a)

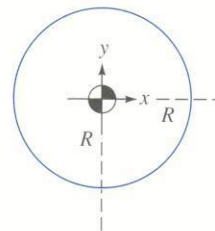

$$A = \pi R^2$$

$$I_{xx} = \frac{\pi R^4}{4}$$

$$I_{xy} = 0$$

(b)

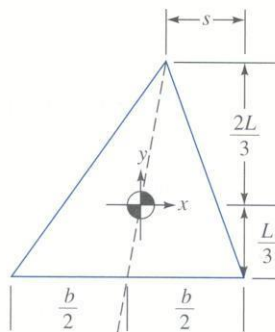

$$A = \frac{bL}{2}$$

$$I_{xx} = \frac{bL^3}{36}$$

$$I_{xy} = \frac{b(b-2s)L^2}{72}$$

(c)

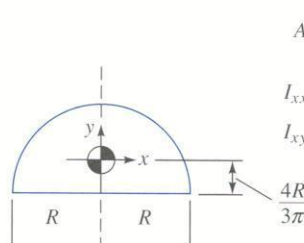

$$A = \frac{\pi R^2}{2}$$

$$I_{xx} = 0.10976R^4$$

$$I_{xy} = 0$$

(d)

Hydrostatic Forces on Curved Surfaces

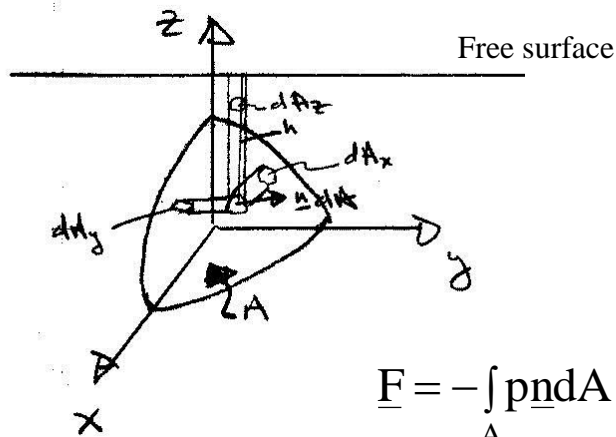

$$p = \gamma h$$

$$\underline{F} = - \int_A p \underline{n} dA$$

$h =$ distance below
free surface

Horizontal Components

(x and y components)

$$F_x = \underline{F} \cdot \hat{i} = - \int_A p \underline{n} \cdot \hat{i} dA$$

$$= - \int_{A_x} p dA_x$$

$dA_x =$ projection of $\underline{n} dA$ onto
vertical plane to x-direction

$$F_y = \underline{F} \cdot \hat{j} = - \int_{A_y} p dA_y$$

$$dA_y = \underline{n} \cdot \hat{j} dA$$

$=$ projection $\underline{n} dA$
onto vertical plane to
y-direction

Therefore, the horizontal components can be determined by some methods developed for submerged plane surfaces.

The horizontal component of force acting on a curved surface is equal to the force acting on a vertical projection of that surface including both magnitude and line of action.

Vertical Components

$$F_z = \underline{F} \cdot \hat{k} = - \int_A p \underline{n} \cdot \hat{k} dA$$

$$= - \int_{A_z} p dA_z \quad p = \gamma h$$

h=distance
below free
surface

$$= \gamma \int_{A_z} h dA_z = \gamma V$$

= weight of
fluid above
surface A

The vertical component of force acting on a curved surface is equal to the net weight of the column of fluid above the curved surface with line of action through the centroid of that fluid volume.

Example: Drum Gate

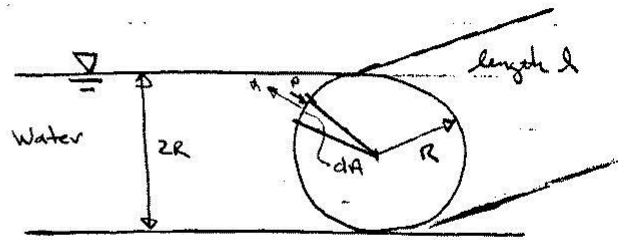
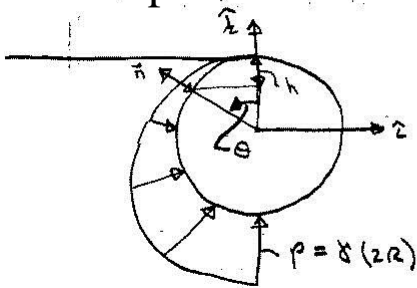

Pressure Diagram

$$p = \gamma h = \gamma R(1 - \cos\theta)$$

$$\underline{n} = -\sin\theta \hat{i} + \cos\theta \hat{k}$$

$$dA = \ell \quad R d\theta : \text{Area } p \text{ acts over (Note: } R d\theta = \text{arc length)}$$

$$\underline{F} = - \int_0^\pi \underbrace{\gamma R(1 - \cos\theta)}_p \underbrace{(-\sin\theta \hat{i} + \cos\theta \hat{k})}_\underline{n} \underbrace{\ell R d\theta}_{dA}$$

$$\underline{F} \cdot \hat{i} = F_x = +\gamma \ell R^2 \int_0^\pi (1 - \cos\theta) \sin\theta d\theta$$

$$= \gamma \ell R^2 \left[-\cos\theta + \frac{1}{4} \cos 2\theta \right]_0^\pi = 2\gamma \ell R^2$$

$$= (\gamma R)(2R \ell) \Rightarrow \underline{\text{same force as that on projection of area onto vertical plane}}$$

$$F_z = -\gamma \ell R^2 \int_0^\pi (1 - \cos\theta) \cos\theta d\theta$$

$$= -\gamma \ell R^2 \left[\sin\theta - \frac{\theta}{2} - \frac{\sin 2\theta}{4} \right]_0^\pi$$

$$= \gamma \ell R^2 \frac{\pi}{2} = \gamma \ell \left(\frac{\pi R^2}{2} \right) = \gamma V$$

\Rightarrow net weight of water above surface

Another approach:

$$F_1 = -\gamma \ell \left[R^2 - \frac{1}{4} \pi R^2 \right]$$
$$= -\gamma \ell R^2 \left[1 - \frac{\pi}{4} \right]$$

$$F_2 = \gamma \ell \frac{\pi R^2}{2} - F_1$$

$$F = F_2 + F_1$$
$$= \frac{\gamma \ell \pi R^2}{2}$$

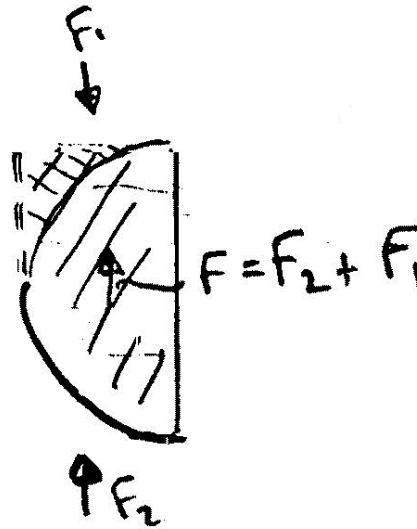

Buoyancy

Archimedes Principle

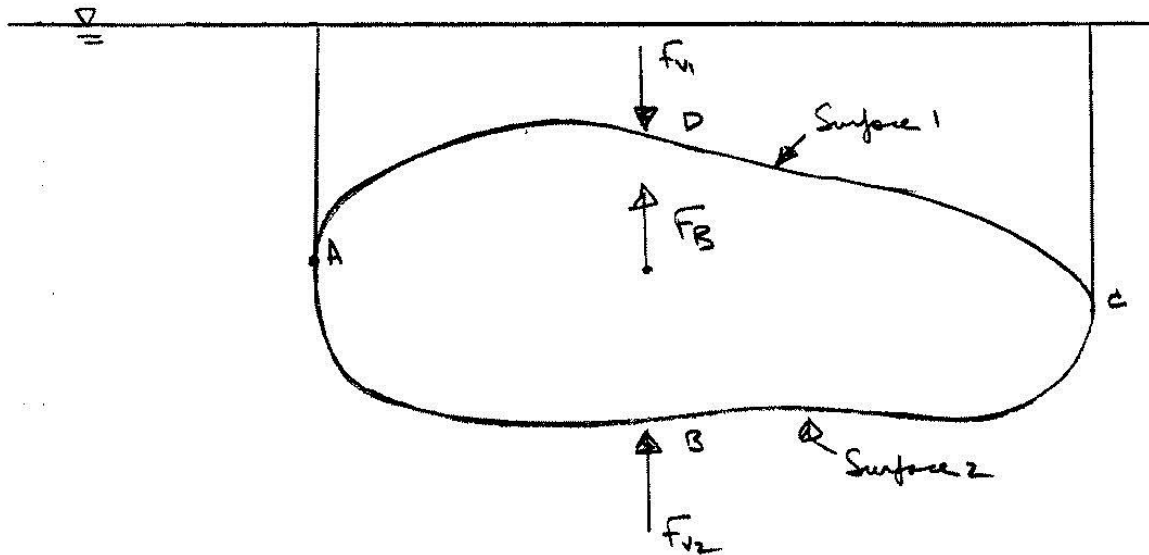

$$F_B = F_{v2} - F_{v1}$$

= fluid weight above Surface 2 (ABC)
 - fluid weight above Surface 1 (ADC)

= fluid weight equivalent to body volume \forall

$$F_B = \rho g \forall \quad \forall = \text{submerged volume}$$

Line of action is through centroid of \forall = center of buoyancy

Net Horizontal forces are zero since

$$F_{BAD} = F_{BCD}$$

Hydrometry

A hydrometer uses the buoyancy principle to determine specific weights of liquids.

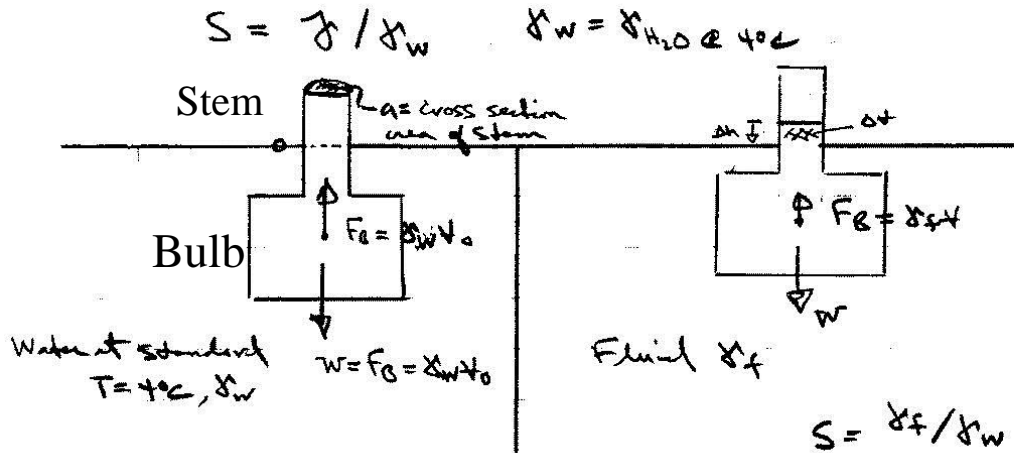

$$F_B = \gamma_w V_o$$

$$W = mg = \gamma_f V = S \gamma_w V = S \gamma_w (V_o - \Delta V) = \underbrace{S \gamma_w}_{\gamma_f} \underbrace{(V_o - a \Delta h)}_V$$

$a = \text{cross section area stem}$

$\Delta h = \text{stem height above waterline}$

$F_B = W$ at equilibrium:

$$\gamma_w V_o = S \gamma_w (V_o - a \Delta h)$$

$$V_o / S = V_o - a \Delta h$$

$$a \Delta h = V_o - V_o / S$$

$$\Delta h = \frac{V_o}{a} \cdot \left(1 - \frac{1}{S}\right) = \Delta h(S); \text{ Calibrate scale using fluids of}$$

known S

$$S = \frac{V_o}{V_o - a \Delta h} = S(\Delta h); \text{ Convert scale to directly read } S$$

Example (apparent weight)

King Hiero ordered a new crown to be made from pure gold. When he received the crown he suspected that other metals had been used in its construction. Archimedes discovered that the crown required a force of 4.7# to suspend it when immersed in water, and that it displaced 18.9 in³ of water. He concluded that the crown was not pure gold. Do you agree?

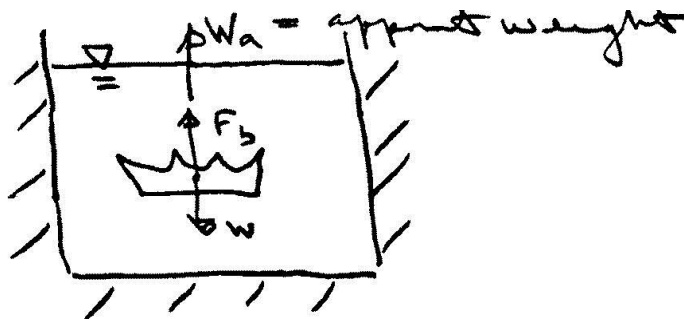

$$\sum F_{\text{vert}} = 0 = W_a + F_b - W = 0 \Rightarrow W_a = W - F_b = (\gamma_c - \gamma_w)V$$

$$W = \gamma_c V, \quad F_b = \gamma_w V$$

$$\text{or } \gamma_c = \frac{W_a}{V} + \gamma_w = \frac{W_a + \gamma_w V}{V}$$

$$\gamma_c = \frac{4.7 + 62.4 \times 18.9 / 1728}{18.9 / 1728} = 492.1 = \rho_c g$$

$$\Rightarrow \rho_c = 15.3 \text{ slugs/ft}^3$$

~ ρ_{steel} and since gold is heavier than steel the crown can not be pure gold

Stability of Immersed and Floating Bodies

Here we'll consider transverse stability. In actual applications both transverse and longitudinal stability are important.

Immersed Bodies

FIGURE 3.15
*Conditions of stability
for immersed bodies.
(a) Stable. (b) Neutral.
(c) Unstable.*

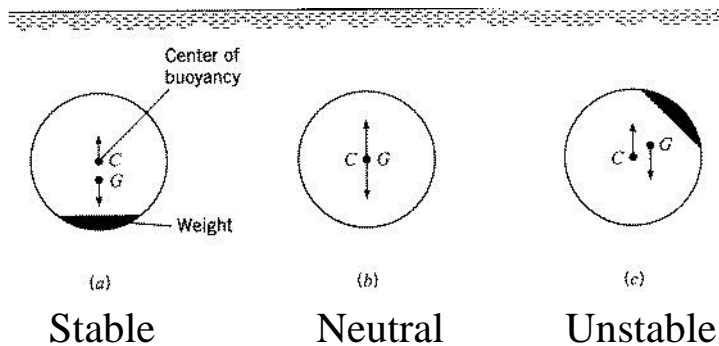

Static equilibrium requires: $\sum F_v = 0$ and $\sum M = 0$

$\sum M = 0$ requires that the centers of gravity and buoyancy coincide, i.e., $C = G$ and body is neutrally stable

If C is above G, then the body is stable (righting moment when heeled)

If G is above C, then the body is unstable (heeling moment when heeled)

Floating Bodies

For a floating body the situation is slightly more complicated since the center of buoyancy will generally shift when the body is rotated depending upon the shape of the body and the position in which it is floating.

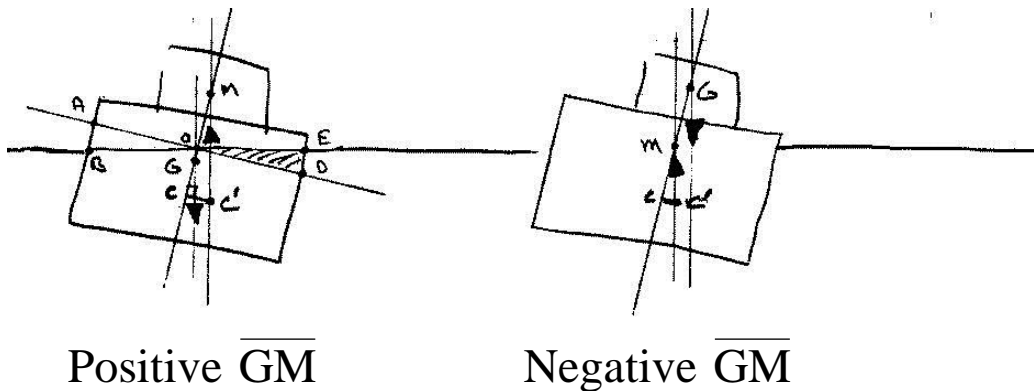

The center of buoyancy (centroid of the displaced volume) shifts laterally to the right for the case shown because part of the original buoyant volume AOB is transferred to a new buoyant volume EOD.

The point of intersection of the lines of action of the buoyant force before and after heel is called the metacenter M and the distance GM is called the metacentric height. If GM is positive, that is, if M is above G, then the ship is stable; however, if GM is negative, the ship is unstable.

Floating Bodies

α = small heel angle

\bar{x} = CC' = lateral displacement of C

C = center of buoyancy
 i.e., centroid of displaced volume ∇

Solve for GM: find \bar{x} using

- (1) basic definition for centroid of ∇ ; and
- (2) trigonometry

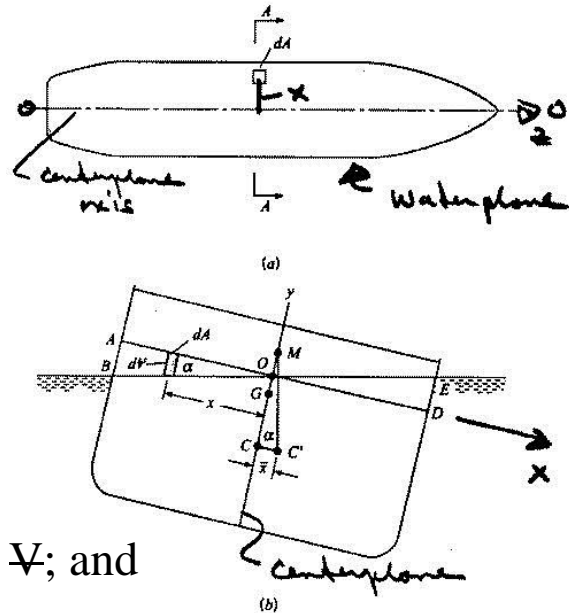

Fig. 3.17

(1) Basic definition of centroid of volume ∇

$$\bar{x}\nabla = \int x dV = \sum x_i \Delta V_i \quad \text{moment about centerplane}$$

$$\begin{aligned} \bar{x}\nabla &= \underbrace{\text{moment } V \text{ before heel}} - \text{moment of } \nabla_{AOB} \\ &\quad + \text{moment of } \nabla_{EOD} \\ &= 0 \text{ due to symmetry of} \\ &\quad \text{original } V \text{ about } y \text{ axis} \\ &\quad \text{i.e., ship centerplane} \end{aligned}$$

$$\bar{x}\nabla = - \int_{AOB} (-x) dV + \int_{EOD} x dV \quad \tan \alpha = y/x$$

$$dV = y dA = x \tan \alpha dA$$

$$\bar{x}\nabla = \int_{AOB} x^2 \tan \alpha dA + \int_{EOD} x^2 \tan \alpha dA$$

$$\bar{x}\nabla = \tan \alpha \int x^2 dA$$

ship waterplane area

moment of inertia of ship waterplane
about z axis O-O; i.e., I_{OO}

I_{OO} = moment of inertia of waterplane
area about centerplane axis

(2) Trigonometry

$$\bar{x}\nabla = \tan \alpha I_{OO}$$

$$CC' = \bar{x} = \frac{\tan \alpha I_{OO}}{\nabla} = CM \tan \alpha$$

$$CM = I_{OO} / \nabla$$

$$GM = CM - CG$$

$$GM = \frac{I_{OO}}{\nabla} - CG$$

$GM > 0$ Stable

$GM < 0$ Unstable

Fluids in Rigid-Body Motion

For fluids in motion, the pressure variation is no longer hydrostatic and is determined from application of Newton's 2nd Law to a fluid element.

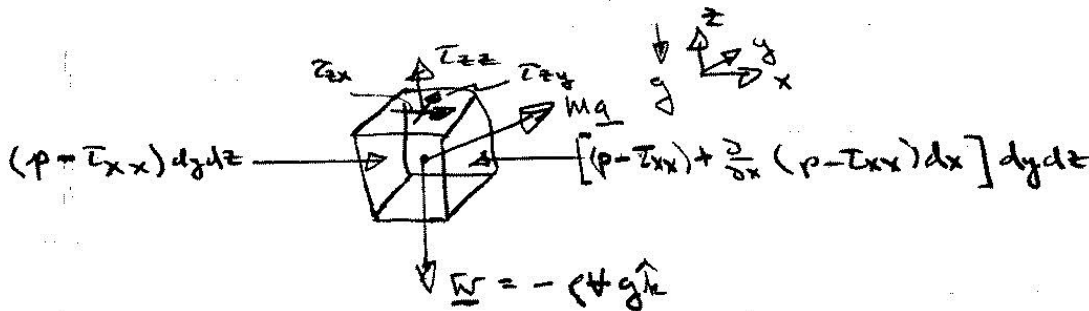

τ_{ij} = viscous stresses
 direction

p = pressure

$\underline{M}\underline{a}$ = inertia force

\underline{W} = weight (body force)

Newton's 2nd Law

net surface force in X

$$\underline{X}_{\text{net}} = \left(\underbrace{-\frac{\partial p}{\partial x}}_{\text{pressure}} + \underbrace{\frac{\partial \tau_{xx}}{\partial x} + \frac{\partial \tau_{yx}}{\partial y} + \frac{\partial \tau_{zx}}{\partial z}}_{\text{viscous}} \right) \underline{V}$$

$$\underline{M}\underline{a} = \sum \underline{F} = \underline{F}_B + \underline{F}_S$$

per unit volume ($\div \underline{V}$) $\rho \underline{a} = \underline{f}_b + \underline{f}_s$

The acceleration of fluid particle

$$\underline{a} = \frac{D\underline{V}}{Dt} = \frac{\partial \underline{V}}{\partial t} + \underline{V} \cdot \nabla \underline{V}$$

$$\underline{f}_b = \text{body force} = -\rho g \hat{k}$$

$$\underline{f}_s = \text{surface force} = \underline{f}_p + \underline{f}_v$$

$\underline{f}_p =$ surface force due to $p = -\nabla p$

$\underline{f}_v =$ surface force due to viscous stresses τ_{ij}

$$\rho \underline{a} = \underline{f}_b + \underline{f}_p + \underline{f}_v$$

Neglected in this chapter and included later in Chapter 6 when deriving complete Navier-Stokes equations

$$\rho \underline{a} = -\rho g \hat{k} - \nabla p$$

inertia force = body force due to gravity + surface force due to pressure gradients

Where for general fluid motion, i.e. relative motion between fluid particles:

$$\underline{a} = \frac{D\underline{V}}{Dt} = \underbrace{\frac{\partial \underline{V}}{\partial t}}_{\text{local acceleration}} + \underbrace{\underline{V} \cdot \nabla \underline{V}}_{\text{convective acceleration}} \quad \text{substantial derivative}$$

$$\begin{aligned} \text{x: } \rho \frac{Du}{Dt} &= -\frac{\partial p}{\partial x} \\ \rho \left[\frac{\partial u}{\partial t} + u \frac{\partial u}{\partial x} + v \frac{\partial u}{\partial y} + w \frac{\partial u}{\partial z} \right] &= -\frac{\partial p}{\partial x} \end{aligned}$$

$$\begin{aligned} \text{y: } \rho \frac{Dv}{Dt} &= -\frac{\partial p}{\partial y} \\ \rho \left[\frac{\partial v}{\partial t} + u \frac{\partial v}{\partial x} + v \frac{\partial v}{\partial y} + w \frac{\partial v}{\partial z} \right] &= -\frac{\partial p}{\partial y} \end{aligned}$$

$$\mathbf{z}: \quad \rho \frac{Dw}{Dt} = -\rho g - \frac{\partial p}{\partial z} = -\frac{\partial}{\partial z}(p + \gamma z)$$

$$\rho \left[\frac{\partial w}{\partial t} + u \frac{\partial w}{\partial x} + v \frac{\partial w}{\partial y} + w \frac{\partial w}{\partial z} \right] = -\frac{\partial}{\partial z}(p + \gamma z)$$

Note: for $\underline{\mathbf{V}} = 0$

$$\nabla p = -\rho g \hat{\mathbf{k}}$$

$$\frac{\partial p}{\partial x} = \frac{\partial p}{\partial y} = 0$$

$$\frac{\partial p}{\partial z} = -\rho g = -\gamma$$

But in this chapter rigid body motion, i.e., no relative motion between fluid particles

$$\rho \underline{\mathbf{a}} = -\nabla(p + \gamma z) \quad \text{Euler's equation for inviscid flow}$$

$$\nabla \cdot \underline{\mathbf{V}} = 0 \quad \text{Continuity equation for incompressible flow (See Chapter 6)}$$

4 equations in four unknowns $\underline{\mathbf{V}}$ and p

For rigid body translation: $\underline{\mathbf{a}} = a_x \hat{\mathbf{i}} + a_z \hat{\mathbf{k}}$

For rigid body rotating: $\underline{\mathbf{a}} = -r\Omega^2 \hat{\mathbf{e}}_r$

If $\underline{\mathbf{a}} = 0$, the motion equation reduces to hydrostatic equation:

$$\frac{\partial p}{\partial x} = \frac{\partial p}{\partial y} = 0$$

$$\frac{\partial p}{\partial z} = -\gamma$$

Examples of Pressure Variation From Acceleration

Uniform Linear Acceleration:

$$\rho \underline{a} = -\rho g \hat{k} - \nabla p$$

$$\nabla p = -\rho(\underline{a} + g \hat{k}) = \rho(\underline{g} - \underline{a}) \quad \underline{g} = -g \hat{k}$$

$$\nabla p = -\rho[a_x \hat{i} + (g + a_z) \hat{k}] \quad \underline{a} = a_x \hat{i} + a_z \hat{k}$$

$$\frac{\partial p}{\partial x} = -\rho a_x \quad \frac{\partial p}{\partial z} = -\rho(g + a_z)$$

$$\frac{\partial p}{\partial x} = -\rho a_x$$

1. $a_x < 0$ p increase in +x

2. $a_x > 0$ p decrease in +x

$$\frac{\partial p}{\partial z} = -\rho(g + a_z)$$

1. $a_z > 0$ p decrease in +z

2. $a_z < 0$ and $|a_z| < g$ p decrease in +z but slower than g

3. $a_z < 0$ and $|a_z| > g$ p increase in +z

$\hat{s} =$ unit vector in direction of ∇p

$$= \nabla p / |\nabla p|$$

$$= \frac{-[a_x \hat{i} + (g + a_z) \hat{k}]}{[a_x^2 + (g + a_z)^2]^{1/2}}$$

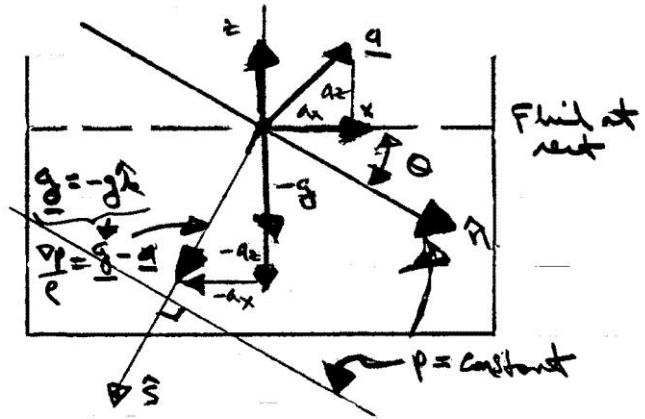

$\hat{n} =$ unit vector in direction of $p =$

$$= \hat{s} \times \hat{j} \quad \text{ijkijk}$$

$$= \frac{-a_x \hat{k} + (g + a_z) \hat{i}}{[a_x^2 + (g + a_z)^2]^{1/2}}$$

\perp to ∇p
 by definition lines
 of constant p are
 normal to ∇p

$\theta = \tan^{-1} a_x / (g + a_z) =$ angle between \hat{n} and x

$$\frac{dp}{ds} = \nabla p \cdot \hat{s} = \rho \underbrace{[a_x^2 + (g + a_z)^2]^{1/2}}_G > \rho g$$

$$p = \rho G s + \text{constant} \Rightarrow p_{\text{gage}} = \rho G s$$

Rigid Body Rotation:

Consider a cylindrical tank of liquid rotating at a constant rate $\underline{\Omega} = \Omega \hat{k}$

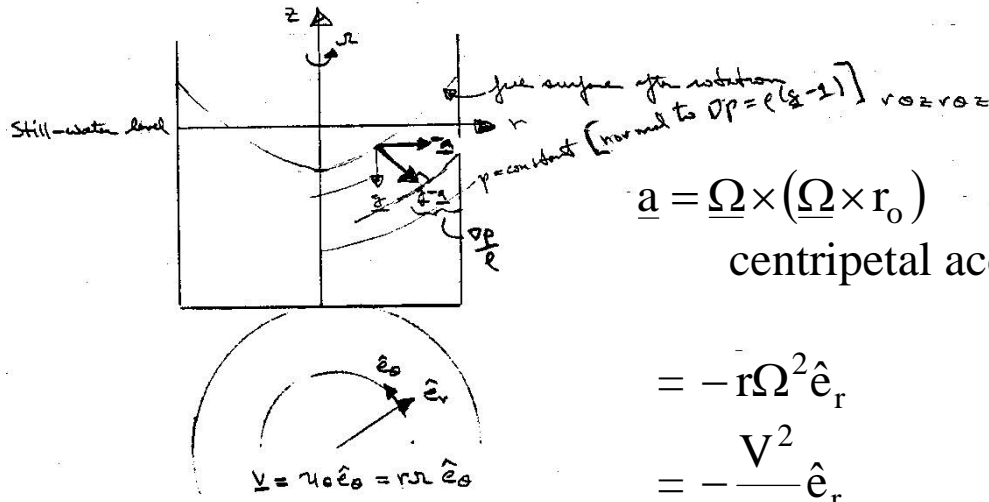

$\underline{a} = \underline{\Omega} \times (\underline{\Omega} \times \underline{r}_o)$
 centripetal acceleration

$= -r\Omega^2 \hat{e}_r$
 $= -\frac{V^2}{r} \hat{e}_r$

$\nabla p = \rho(\underline{g} - \underline{a})$
 $= -\rho g \hat{k} + \rho r \Omega^2 \hat{e}_r$
 coordinates

$\nabla = \frac{\partial}{\partial r} \hat{e}_r + \frac{1}{r} \frac{\partial}{\partial \theta} \hat{e}_\theta + \frac{\partial}{\partial z} \hat{e}_z$
 grad in cylindrical

i.e., $\frac{\partial p}{\partial r} = \rho r \Omega^2$

$\frac{\partial p}{\partial z} = -\rho g$

$\frac{\partial p}{\partial \theta} = 0$

pressure distribution is hydrostatic in z direction

and $p = \frac{\rho}{2} r^2 \Omega^2 + f(z) + c$

$p_z = -\rho g$
 $p = -\rho g z + C(r) + c$

$p = \frac{\rho}{2} r^2 \Omega^2 - \rho g z + \text{constant}$

$\frac{p}{\gamma} + z - \frac{V^2}{2g} = \text{constant}$
 $V = r\Omega$

The constant is determined by specifying the pressure at one point; say, $p = p_o$ at $(r, z) = (0, 0)$

$$p = p_o - \rho g z + \frac{1}{2} r^2 \Omega^2 \rho$$

Note: pressure is linear in z and parabolic in r

Curves of constant pressure are given by

$$z = \frac{p_o - p}{\rho g} + \frac{r^2 \Omega^2}{2g} = a + br^2$$

which are paraboloids of revolution, concave upward, with their minimum point on the axis of rotation

Free surface is found by requiring volume of liquid to be constant (before and after rotation)

The unit vector in the direction of ∇p is

$$\hat{s} = \frac{-\rho g \hat{k} + \rho r \Omega^2 \hat{e}_r}{\left[(\rho g)^2 + (\rho r \Omega^2)^2 \right]^{1/2}}$$

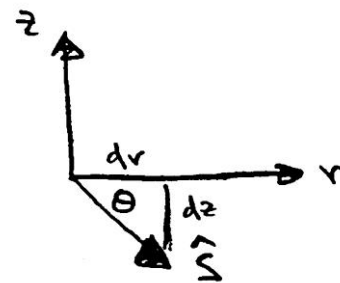

$$\tan \theta = \frac{dz}{dr} = -\frac{g}{r \Omega^2} \quad \text{slope of } \hat{s}$$

$$\text{i.e., } r = C_1 \exp\left(-\frac{\Omega^2 z}{g}\right) \quad \text{equation of } \nabla p \text{ surfaces}$$

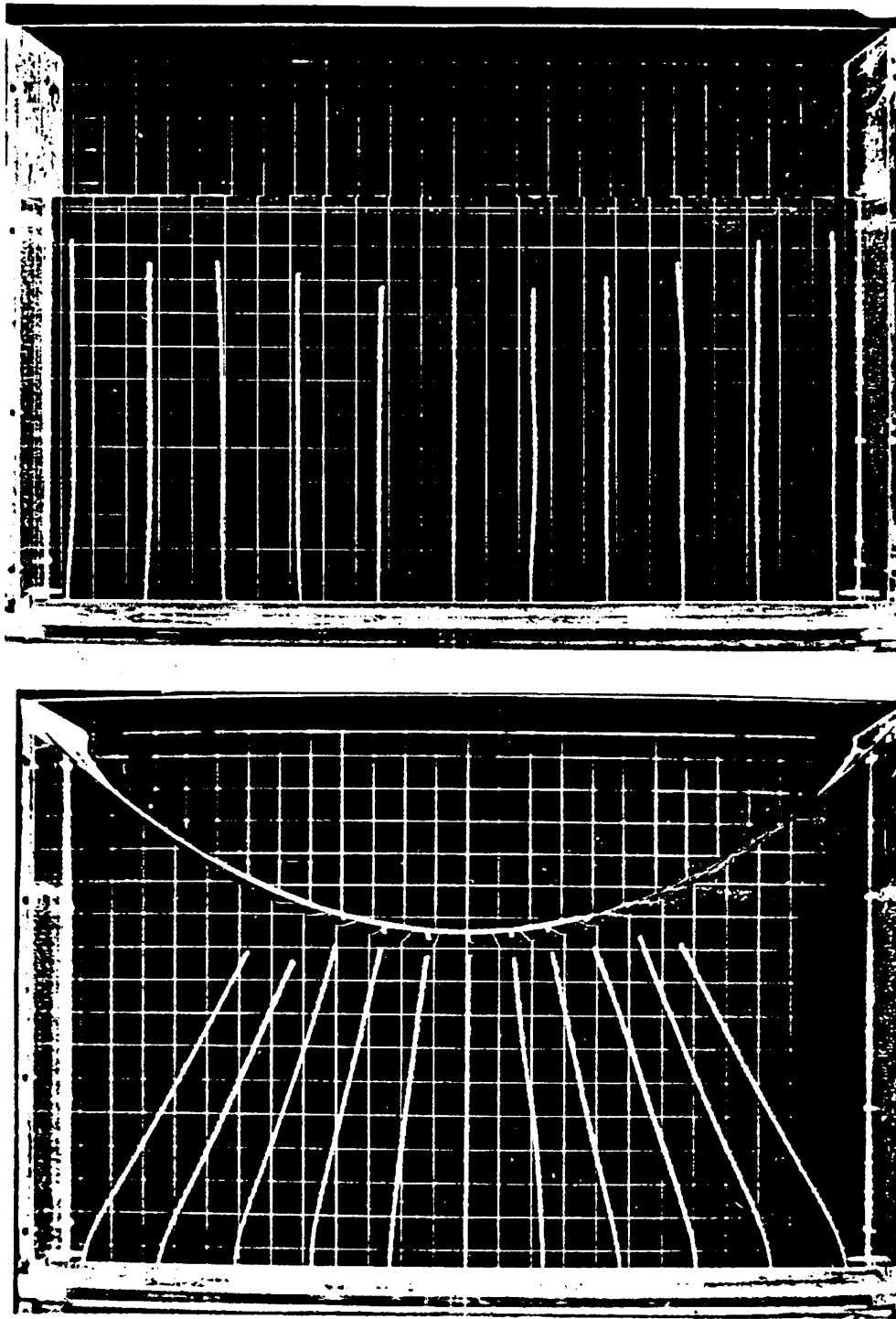

Fig. 2.23 Experimental demonstration with buoyant streamers of the fluid force field in rigid-body rotation: (top) fluid at rest (streamers hang vertically upward); (bottom) rigid-body rotation (streamers are aligned with the direction of maximum pressure gradient). (From Ref. 5. Courtesy of R. Ian Fletcher.)

94 PRESSURE DISTRIBUTION IN A FLUID